

规格书

WWT121-04-49

24M工业镜头

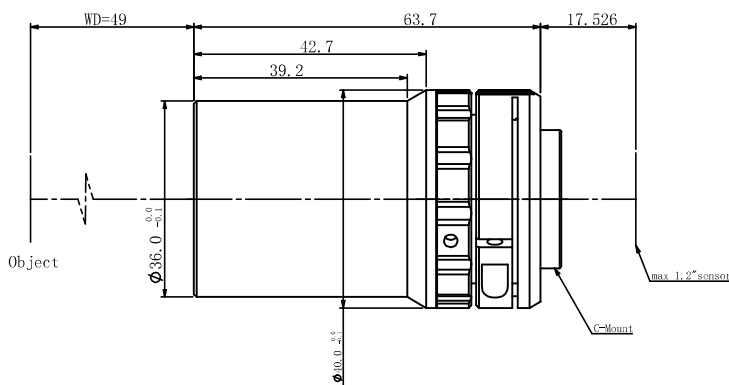

光学参数

放大倍率 β (x)	0.4
物方工作距 WD (mm)	49
支持 CCD 尺寸 (Φ mm)	19.2(1.2")
像方 F/#	7.2
焦距 (mm)	24.87
数值孔径 NA	0.0278
物方分辨率 (μ m)	12.1
物方景深 DoF (mm)	3.6
像方 MTF30 (lp/mm)	78
TV 畸变 (%)	0.46

视野范围 (mm × mm)

1.2" IMX530/540 (14.6X12.6)	36.5x31.5
-----------------------------	-----------

机械参数

相机接口	C
镜头总长 (mm)	63.7
是否同轴光 / 可调光栏	否 / 否

