

规格书

WWT118-015-92

6M 工业镜头

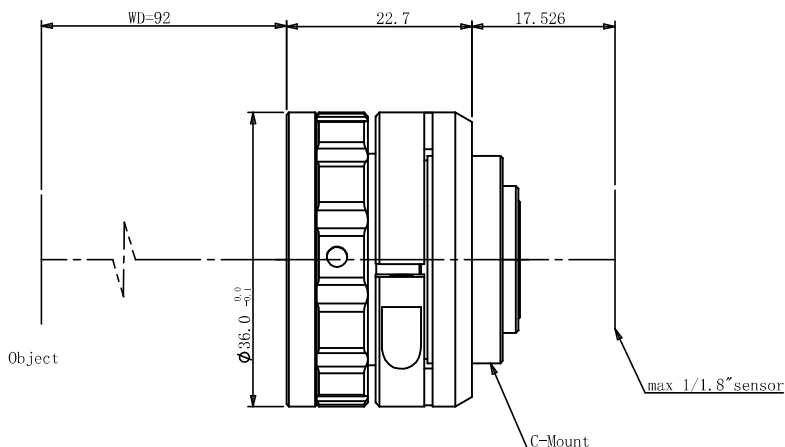

光学参数

放大倍率 β (x)	0.15
物方工作距 WD (mm)	92
支持 CCD 尺寸 (Φ mm)	9(1/1.8")
像方 F/#	8.0
焦距 (mm)	24.97
数值孔径 NA	0.00936
物方分辨率 (μ m)	41.3
物方景深 DoF (mm)	49.0
像方 MTF30 (lp/mm)	100
像方畸变 (% max)	0.8

视野范围 (mm × mm)

1/1.8" (7.37x4.92)	49.1x32.8
--------------------	-----------

机械参数

相机接口	C
镜头总长 (mm)	22.7
是否同轴光 / 可调光栏	否 / 否

